

# FACTORY FURNITURE

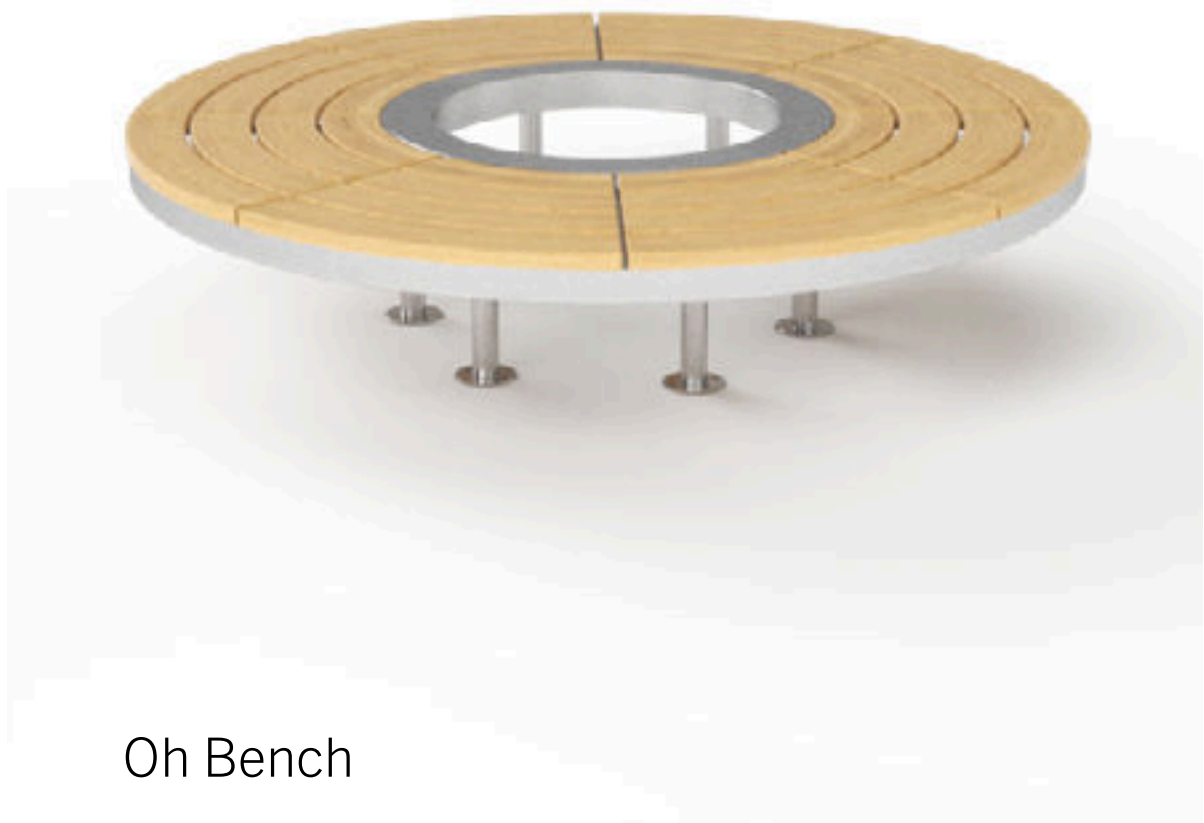

## Oh Bench

OPERATION & MAINTENANCE MANUAL

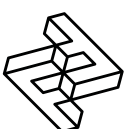

# Introduction

## Design

Design, shop drawings and development by Factory Furniture Ltd.

## Manufacture

Factory Furniture manufactured components. Products are assembled in Factory workshops, checked and dispatched ready for installation. Replacement products or components thereof should be ordered direct from Factory Furniture Ltd.

## Copyright

The design copyright for the product and drawing copyright remains the sole property of Factory Furniture Ltd.

# General Specifications

## Wood Bench

*Metric* length 1900mm | width 1900mm  
| height 440mm

*Imperial* length 6' 3" | width 6' 3" | height 1' 5½"

**Approx Weight** 147kg

**Fixing Centres** 6 no. legs - centre radius 400mm - 60° spacings (*See drawing at the end of document*)

# Materials & Finishes

## Bench Slats

- Manufactured from FSC® certified tropical hardwood
- Profiled and left untreated as standard (oil or microporous woodstain treatment available on request)
- Supported by and fixed to frame with 4 no. fixing points per slat



## Frame / bases

- Frame and legs manufactured from stainless steel with satin polished finish
- Frame comes in 2 halves to allow for assembly around tree or column on site
- Frame halves and legs feature an all welded construction
- Frame halves are bolted together once in position using 8 off M8 x 20mm button head bolts & locknuts
- Each leg anchored into suitable concrete foundation via 2 no. resin fixed M10 x 130mm threaded rods and cap nuts per base (12 no. total)

# General Maintenance

(Recommended Schedule & Guidelines)

## Daily/Weekly/Monthly (or as adopted)

Visual checks of bench top, frame and legs - check all items for superficial or physical damage.

## Three Monthly

Clean all items as detailed below check all fixings are seated correctly; inspect timber for serious damage and splinters.

## Six Monthly

Secure all fixings; full clean as detailed below; check that bench is firmly secured to the ground

# Specific Maintenance Details

## FSC Timber

Clean with a stiff brush once per year, especially in more exposed locations, in order to prevent a verdigris type build up on the timber surface. Ideally this should be completed in early spring. During the cleaning stage, all exposed timber surfaces should be inspected for splits and splinters. Any splinters and graffiti should be removed and the surface sanded with 100 grit sandpaper in order to remove any uneven / sharp edges or surfaces.

*During the first few months after installation the tannin naturally occurring in the timber may leach out and cause a brown staining on the bases. This may be removed with a light solution of household bleach and water.*

## Stainless Steel (polished stainless steel only)

Clean as required, but at least every three months, using a stainless steel polish and a lint free cloth. To remove ground in dirt, a stainless steel finishing pad may be required.

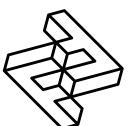

# Repairs

## FSC Timber

For light damage, please see section on specific maintenance details above. For instances of heavy damage, the timber item should be replaced. Please order against the part number reference in the reordering section towards the end of this manual.

## Stainless Steel

Light damage (surface scratches etc.) can be removed using an emery pad (240 grit) and freeing oil such as 'WD40'. Care should be taken to follow the direction of the brushing grain. It is recommended that a trial repair be carried out on an unimportant surface first. No corrosive cleaners or other abrasives should be used. Any contamination, particularly carbon steel scuffs from vehicles, should be quickly removed to avoid corrosion.

## Heavy Damage

In the event of serious damage to any component, replacements should be ordered from Factory Furniture Ltd. Should further assistance be required (or if the product needs to be disassembled for any reason), please contact Factory Furniture for detailed technical advice.

# Installation Instructions

**All installation works to be carried out by competent personnel - install as complete unit.**

## Oh Bench

1. Install suitable foundation pads (see illustration) each with top face at ground level
2. Position bench halves around tree or column and bolt frames together with 8 no. M8 x 20mm button head bolts and lock nuts (supplied)
3. Position bench in correct orientation with frame centred on tree / column; then mark hole positions through base plates onto foundation pads
4. Move the bench and drill holes  $\text{Ø}12\text{mm} \times 125\text{mm}$  deep
5. Clear debris from holes
6. Fill the holes to within approximately 35mm from the top with Hilti HY150 resin (or similar). Lift the bench (placing threaded anchor rods/capnuts in place) and carefully lower the anchors into the holes, leave for two hours before continuing
7. Using a torque wrench, tighten nuts and washers over base plates to 30Nm to fasten down the bench
8. Check bench level

## IMPORTANT NOTE

Ensure that stainless steel is protected during site cutting of stone – contamination from disc cutters will produce corrosion on stainless steel components.

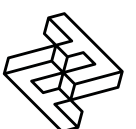

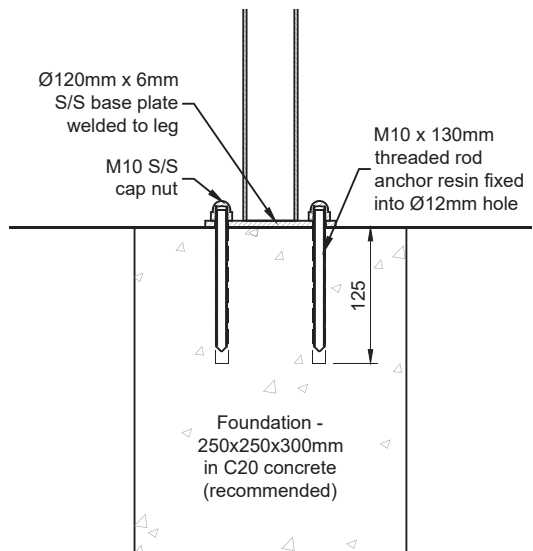
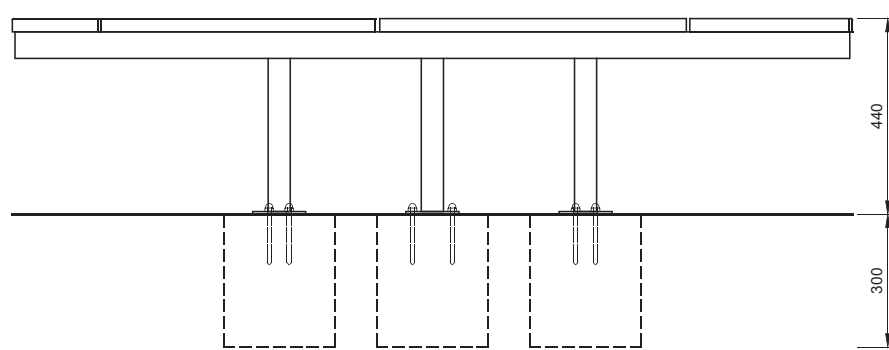
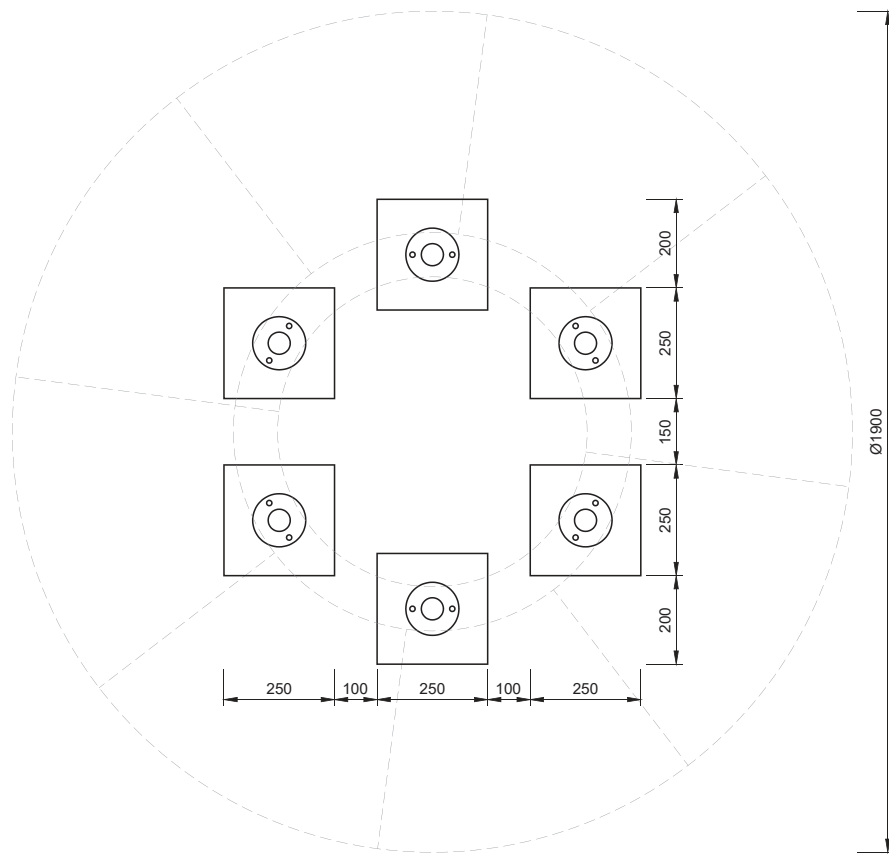

5 Pioneer Road, Faringdon,  
 Oxfordshire SN7 7BU  
 +44 (0)1367 242731  
 hello@factoryfurniture.co.uk

**factoryfurniture.co.uk**

