

FACTORY FURNITURE

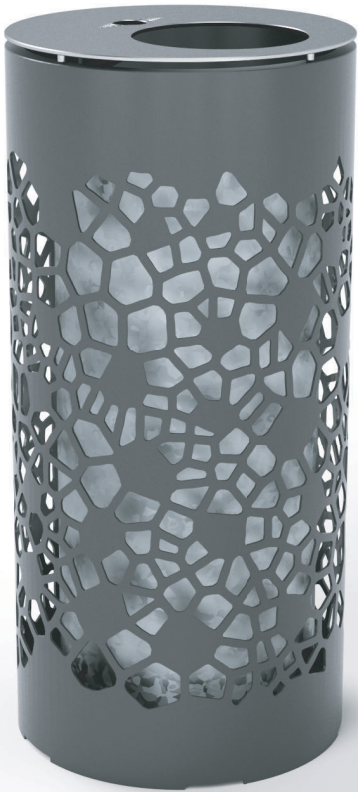

Small Osso Bin

OPERATION & MAINTENANCE MANUAL

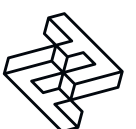

Introduction

Design

Design, shop drawings and development by Factory Furniture Ltd.

Manufacture

Factory Furniture manufactured components. Products are assembled in Factory workshops, checked and dispatched ready for installation. Replacement products or components thereof should be ordered direct from Factory Furniture Ltd.

Copyright

The design copyright for the product and drawing copyright remains the sole property of Factory Furniture Ltd.

General Specifications

Bin

Metric length 400mm | width 400mm | height 850mm

Imperial length 1' 3½" | width 1' 3½" | height 2' 9½"

Approx Weight 27kg

Liner Capacity 55ltr

Fixing Centres 215mm (8½") x 190mm (7½")

Detailed Material & Finish Specifications

Bin Lid

- Manufactured from stainless steel with satin polish finish and featuring an all welded construction
- Lid is hinged to allow access to removable bin liner

Bin Body

- Manufactured from hot dipped galvanised mild steel with a polyester powder coated finish (*powder coat colour dark grey as standard or to customer specification*)
- Bin features an all welded construction apart from bolt on lid hinge bracket
- Anchored using 3 no. M10 x 75mm sleeve anchors concealed in base

Bin Liner

- Liner is removable
- Manufactured from pre-galvanised mild steel sheet
- Drainage holes in base

General Maintenance

(Recommended Schedule & Guidelines)

Daily/Weekly/Monthly (or as adopted)

Visual checks of bin and liner - check all items for superficial or physical damage

Three Monthly

Clean all items as detailed below check all fixings are seated correctly

Six Monthly

Secure all fixings; full clean as detailed below; check that bin is firmly secured to the ground

Specific Maintenance Details

Stainless Steel (polished stainless steel only)

Clean as required, but at least every three months, using a stainless steel polish and a lint free cloth. To remove ground in dirt, a stainless steel finishing pad may be required.

Polyester Powder Coated & Galvanised

For general cleaning using a damp cloth and warm soapy water only. Scourers and abrasive cleaners are NOT suitable for these types of finish and may damage them. Before using any cleaning agents to remove graffiti etc. try on a small, inconspicuous area first to avoid causing more unsightly damage.

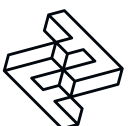

Repairs

Stainless Steel

Light damage (surface scratches etc.) can be removed using an emery pad (240 grit) and freeing oil such as 'WD40'. Care should be taken to follow the direction of the brushing grain. It is recommended that a trial repair be carried out on an unimportant surface first. No corrosive cleaners or other abrasives should be used. Any contamination, particularly carbon steel scuffs from vehicles, should be quickly removed to avoid corrosion.

Polyester Powder Coated Surfaces

For light damage (scratches, chips etc.) repair using touch-up paint to match original colour (available from Factory Furniture Ltd). Paint application should be carried out in accordance with approved methods detailed by the paint manufacturer. Please note that it is advisable to use professional painters to achieve best results when touching up larger areas. Products for respraying larger areas are available from Factory Furniture Ltd.

Heavy Damage

In the event of serious damage to any component, replacements should be ordered from Factory Furniture Ltd. In this event (or if the product needs to be disassembled for any reason), please contact Factory Furniture for detailed technical advice.

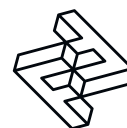

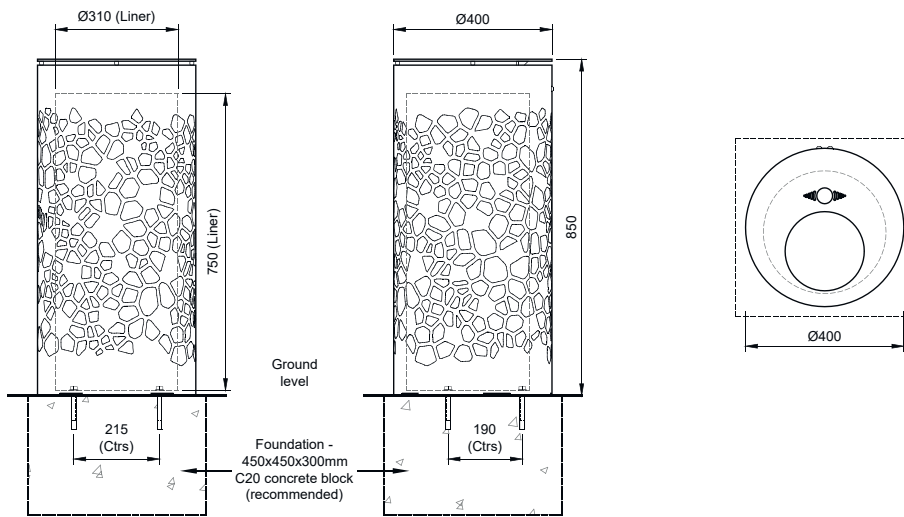

Small Osso Bin (Surface Fix Only)

Installation Instructions

All installation works to be carried out by competent personnel - install as complete unit.

Small Osso Bin (surface fix only)

1. Install suitable foundation pad (see illustration) with top face at ground level
2. Position bin in correct orientation with base centrally on foundation pad, then mark hole positions through base plate
3. Remove the bin; drill holes $\text{Ø}12\text{mm}$ x 85mm deep or as manufacturer's instructions

4. Clear debris from holes
5. Reposition bin and fix to foundation pads using 3 no. zinc-coated M10 x 75mm sleeve anchors tightened to 50Nm (or as per manufacturer's instruction). Ensure bin remains level during fixing process

IMPORTANT NOTE

Ensure that stainless steel is protected during site cutting of stone – contamination from disc cutters will produce corrosion on stainless steel components.

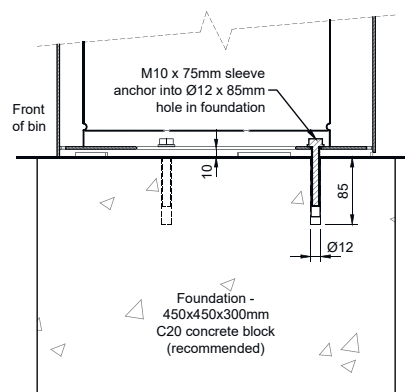
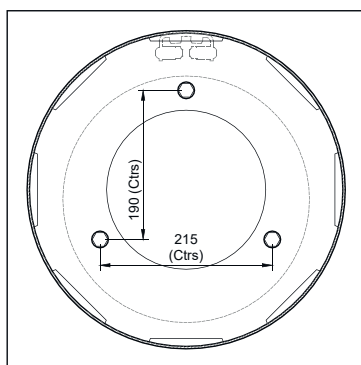

Fixing detail

5 Pioneer Road, Faringdon,
Oxfordshire SN7 7BU
+44 (0)1367 242731
hello@factoryfurniture.co.uk

factoryfurniture.co.uk

